

MAC3 SERIES

Digital Controller
Communication Interface
(RS - 485)
Instruction Manual

Thank you for purchasing SHIMAX product. Please check that the product is the one you ordered. Please operate after you read the instruction manual and fully understand it.

This instructions manual describes the communication interface, or option function of digital controller MAC 3. See the attached main body's instructions manual about operation of MAC 3, and the details of each parameter.

Table of Contents

1. Outline	2	5. Outline of Standard	
		Serial Communications Protocol	7 ~ 15
		5-1 Communication Step	7
		5-2 Communication Format	7
		5-3 Read Command (R) Details	1 1
		5-4 Write Command (W) Details	1 3
		5-5 Answering Code Details	1 4
		5-6 Communication Data Address Details	1 5
2. Specification	2	6. Outline of MODBUS	
3. Connection with Host Computer	3	Communication Protocol	1 6 ~ 2 4
3-1 RS-485	3	6-1 Communication Procedure	1 6
3-2 Control of Three State Output	3	6-2 Communication Format	1 7
4. Setup Concerning Communication	4 ~ 6	6-3 Error Checking	1 9
4-1 Setup of Communication Speed	4	6-4 Data Read-out Details	2 0
4-2 Setup of Communication Data Length	4	6-5 Data Write-in Details	2 1
4-3 Setup of Communication Parity	4	6-6 Loopback Test Details	2 2
4-4 Setup of Communication Stop Bit	4	6-7 No Response Conditions	2 2
4-5 Setup of Start Character	4	6-8 Error Message Details	2 3
4-6 Setup of BCC Operation Type	4	6-9 Communication Data Address Details	2 4
4-7 Setup of Communication Address	5	7. Communication Master	
4-8 Setup in Master Mode	5	Mode Outline	2 5
4-9 Setup of Start Slave Address	5	7-1 Master/Slave Connection	2 5
4-10 Setup of End Slave Address	5	7-2 Communication Details	2 5
4-11 Setup of Write-in Data Address	5	8. Communication Data Address List	2 6 ~ 3 2
4-12 Setup of Delay Time	6	9. Supplementary Explanation	3 3 ~ 3 4
4-13 Setup in Communication Memory Mode	6	9-1 Measuring Range Code Table	3 3
		9-2 Event Code Table	3 4
		10. ASCII Code Table	3 4

1. Outline

The MAC 3 communication interface has adopted the communication method of RS-485.

The various data can be set up with the signal based on EIA standard, or it can read with the personal computer etc.

RS-485 is the data communication standard decided by the Electronic Industries Alliance (EIA).

This standard specified so-called electric and mechanical hardware.

The software portion of the data transmission procedure is not specified.

Therefore, the set with the same interface cannot always communicate each other.

Therefore, the customer fully needs to understand specification and the transmission procedure beforehand.

Use of RS-485 makes it possible to carry out parallel connection of two or more MAC3.

Not many personal computers seem to support this interface.

RS-232C \longleftrightarrow RS-485

However, use of the line converter makes it possible.

2. Specification

Protocol	: SHIMAX standard serial protocol, MODBUS ASCII, MODBUS RTU
Signal level	: in conformity with EIA RS-485
Communication method	: RS-485 Two-wire system Half duplex Multidrop (bus) system
Synchronic system	: Start-stop Synchronous system
Communication range	: RS-485 Maximum 500m totally (depends on the environmental condition)
Transmission speed	: 1200, 2400, 4800, 9600 and 19200, 38400 bps
Transmission procedure	: No procedure
Start bit	: 1 bit
Data length	: 7 bits, 8 bits (MODBUS RTU is fixed to 8 bits)
Parity bit	: nothing, the even number, odd number
Stop bit	: 1 bit, 2 bits
Communication code	: ASCII code (SHIMAX standard serial protocol, MODBUS ASCII) binary code (MODBUS RTU)
Connectable maxim number	: 32 (including a host controller)
Insulation	: Not insulate to analog output. MAC 3 is basic insulation to various input and output, and electric power source

*MODBUS is a registered trademark of Schneider Electric.

3. Connection with Host Computer

3-1. RS-485

The input-and-output logic level of MAC3 is fundamentally as follows.

mark (1) state - terminal < + terminal
 mark (0) state - terminal > +terminal

However, + terminal and - terminal of the controller are high impedance until just before starting transmission, the above-mentioned level is output. (See **3-2. Control of Three State Control**)

[RS-485]

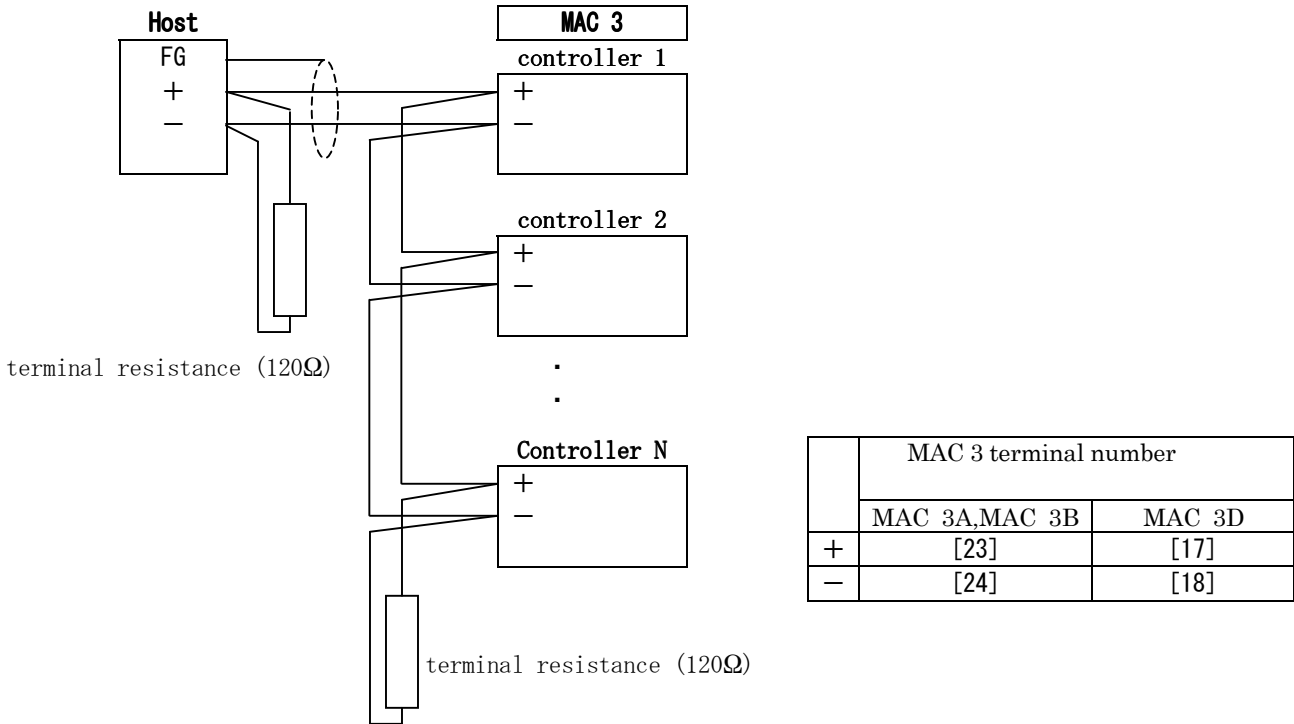

Note 1: Attach 1/2W 120Ω terminal resistance of between the host side and one end terminal equipment (between + and -) at the time of operation.

Note 2: Please be sure to connect one side of a shield to the ground.
 When wiring by a shielding wire cannot be performed, the customer should take the measure against lightning surge.

3-2. Control of Three State Output

RS-485 is a multidrop system. Transmitting output is always high impedance at the time of un-communicating and reception, in order to avoid the collision of a transmitted signal.

Just before transmitting, it changes to a normal output state from high impedance. And it returns to high impedance again at the same time transmission is completed.

However, the control of 3 state control has about 2 msec (MAX.) time-lag. Set up more than several msec delay time, when the host side starts transmission immediately after the end of reception.

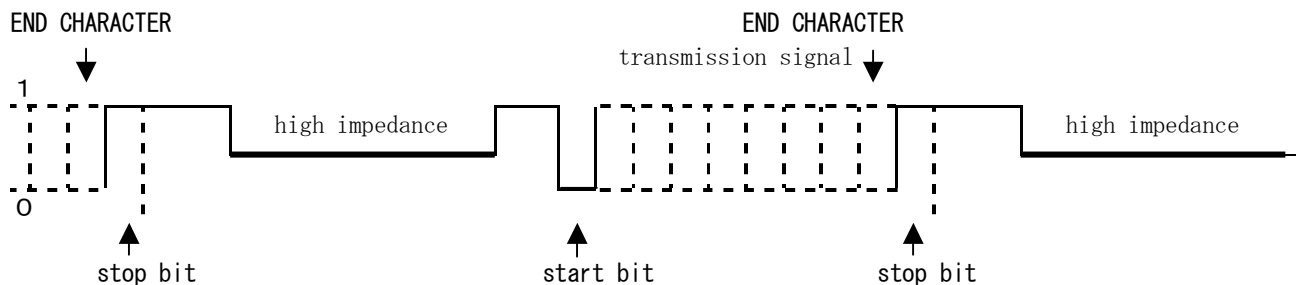

4. Setup Concerning Communication

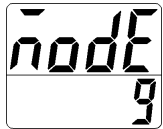

MAC3 has 13 kinds of parameters concerning communication after Mode 9. These cannot perform setting change by communication except for a communication memory mode setup. Perform it by a front key.

MENU key

4-1. Setup of Communication Speed



Initial value : 96
 Setting range : 12 (1200bps) 24 (2400bps), 48 (4800bps), 96 (9600bps) 192 (19200bps), 384 (38400bps)

The transmission speed for transmitting data to a host is chosen and set up.

MENU key

4-2. Setup of Communication Data Length



Initial value : 7
 Setting range : 7, 8

Communication data bit length is chosen and set up. (Fixed at 8 bits at the time of MODBUS RTU setup)

MENU key

4-3. Setup of Communication Parity



Initial value : none
 Setting range : none, odd number, even number
 Communication parity is chosen and set up.

MENU key

4-4. Setup of Communication Stop Bit



Initial value : 1
 Setting range : 1,2
 Communication stop bit is chosen and set up.

MENU key

4-5. Setup of Start Character



Initial value : STX
 Setting range : STX,ATT
 Control code to be used is chosen. (Effective only when SHIMAX standard serial protocol is on)

MENU key

choice	start character	text end character	end character
STX	STX (02H)	ETX (03H)	CR (0DH)
ATT	"@" (40H)	":" (3AH)	CR (0DH)

4-6. Setup of BCC Operation Type

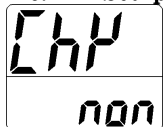

Initial value : none
 Setting range : none,Add,Add2,Xor,LrC,Cr16
 BCC operation type is chosen. The content selected here determines the protocol.

MENU key

choice	operation method	protocol
none	none	SHIMAX standard serial protocol
Add	addition	
Add 2	addition+ complement of 2	
Xor	exclusive OR	
LrC	LRC	MODBUS ASCII
Cr16	CRC-16	MODBUS RTU

4-7. Setup of Communication Address (Slave Address)

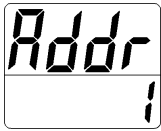

Initial value : 1

Setting range : MAST,1~255

RS-485 adopts the multidrop system and up to 31 equipments (maximum) are connectable.

By allotting an address (machine No.) to the each equipment, only specified-address holding equipment can respond.

MENU key

Note 1: An address can be set up to 1~255. However, the maximum number of connectable equipment is 31.

Note 2: The numbers of addresses you can appoint as a slave is 1~247 in the specification of MODBUS. (Since appointment is possible in 1~255)

Note 3: When decrement is further carried out from Address 1, and decided, MAC3 operates as master mode (~~MASTER~~)

4-8. Setup of Master Mode



Initial value : SV

Setting range : SV,OUT1,OUT2

The type of data that should be transmitted to the slave side is chosen, at the time of master mode.

(A screen is displayed only at the time of master mode)

SV: Transmit the present Execution SV to a slave.

MENU key

OUT 1: As the data converted with the measuring range by the side of master, output % of output 1 is transmitted to slave.

OUT 2: As the data converted with the measuring range by the side of master, output % of output 2 is transmitted to slave.

At the time of out 1 and out 2, (measuring range span × output %) + measuring range lower limit is the actual transmit data.

4-9. Setup of Start Slave Address

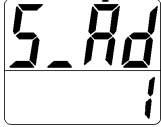

Initial value : 1

Setting range : 1~255

At a maximum, data can be continuously transmitted up to 31 equipments, at the time of master mode.

The start number of the slave address which transmits data is chosen here.

MENU key

(Screen is displayed only at the time of master mode)

4-10. Setup of End Slave Address



Initial value : 31

Setting range : 1~255

At a maximum, data can be continuously transmitted up to 31 equipments, at the time of master mode.

The end number of the slave address which transmits data is chosen here.

MENU key

(A screen is displayed only at the time of master mode)

Note 1: End slave address can be set up only within the limits of start slave address ~ start slave address + 30.

Set start and end slave address in the same value if transmitting object is only one.

4-11. Setup of Write-in Data Address



Initial value : 0300H

Setting range : 0000H~FFFFH

The data address by the side of the slave which rewrites data is chosen, at the time of master mode.

(A screen is displayed only at the time of master mode)

MENU key

Note 1: In a digital controller of SHIMAX, 0300H is, as standard, assigned as SV 1.

4-12. Setup of Delay Time



Initial value : 20
 Setting range : 1~500(msec)

The minimum delay time, from receiving a communication command to actual transmission, can be set up.

MENU key

Note 1: A certain line converter may require longer time for 3 state control, and a signal collision may occur in the case of RS-485.

If delay time is lengthened, it is avoidable.

Caution is required when especially the transmission speed is slow. (1200 bps, 2400 bps, etc.)

Note 2: The actual delay time, from receiving communication command to actual transmission, is the sum total of the above-mentioned delay time, and the processing time by software.

Especially in the case of write command, command processing time may require around 400 msec.

4-13. Setup in Communication Memory Mode



Initial value : RAM
 Setting range : RAM,MIX,EEP

Since write cycle of nonvolatile memory EEPROM is limited, the life of EEPROM becomes shorter when data is frequently rewritten by communication.

Set up RAM mode when data is frequently rewritten by communication. Life of EEPROM can be lengthened, if only RAM data is rewritten without rewriting EEPROM.

MENU key

choice	content of processing
RAM	In this mode, in changing data by communication, only RAM is rewritten. RAM data will be eliminated if power is turned OFF without rewriting to EEPROM. If power is turned on again, it will start by the data memorized by EEPROM.
MIX	In this mode, the data of FIX-SV 1-4 and OUT 1 ~ 2 manual output value is written only in RAM, and the other data are written in RAM and EEPROM.
EEP	Everytime the data is changed by communication, rewriting of RAM and EEPROM is performed. The data is saved even if power is turned off.

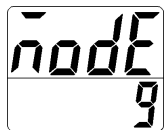

5. Outline of Standard Serial Communications Protocol

MAC 3 adopts SHIMAX standard serial communications protocol.

Change of data is possible with the same communication format, even if the different series of equipment which adopts the standard serial protocol is connected.

5-1. Communication Procedure

(1) The relation between master and slave

- The personal computer, PLC (host) is master side.
- MAC3 is slave side.

- Communication begins by the communication command from the master side, and end by the communication response from the slave side.

However, communication response is not performed when abnormalities, such as communication format error or BCC error, have been recognized.

(2) Communication procedure

The slave side answers the master side, transmitting right shifts mutually, and communication procedure is performed.

(3) Timeout

After receiving a start character, when reception of an end character is not completed within 1 second, it is considered as a timeout. Wait another command (new start character).

In setting up timeout by the host side, set it up with 1 second or more.

5-2. Communication Format

(1) Communication format outline

Communication format consists of basic format part I, text part, and basic format part II.

1) Outline of communication command format

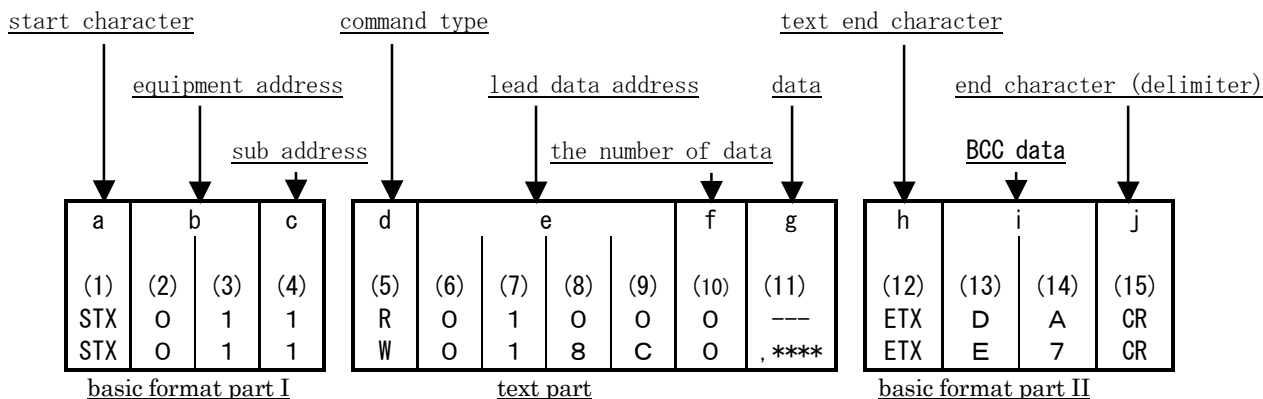

2) Communication answering format

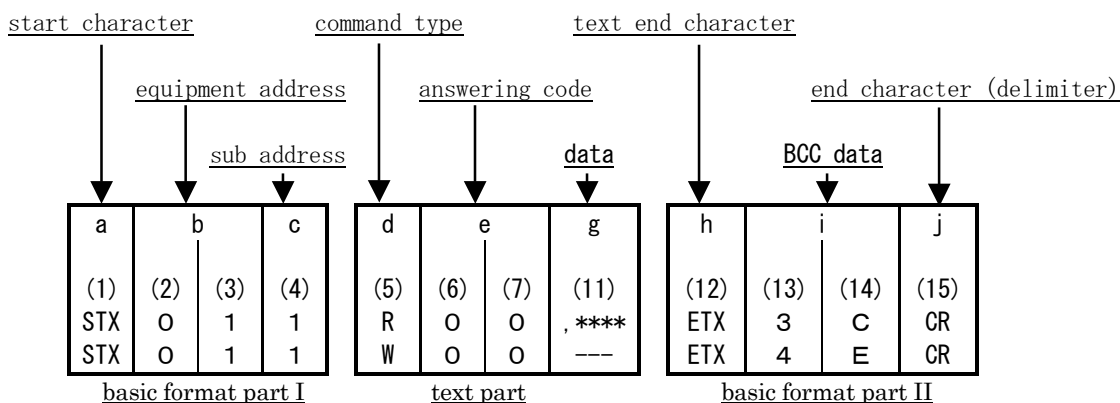

- Basic format part I, II is common at the time of Read command (R), Write command (W), and communication response.

The each-time operation result data is inserted into BCC data, < i (13), (14) >.

- Text part changes with command type, data address, communication responses, etc.

(2) Details of Basic format part I

a: Start character [(1): single-digit / STX (02H), or "@" (40H)]

- The character shows that this is head of communication.
- If start character is received, it will be judged as the 1st letter of new communication.
- A start character and the end character of text are chosen by a pair.
(See 4-5. **Setup of Start Character**)

STX (02H) ---chosen by ETX (03H)
"@"(40H) ----chosen by ":" (3AH).

b: Equipment address [(2), (3):double-digit]

- Appoint the equipment for communication.
- Address can be appointed in 1~255 (decimal number).
- Binary digit 8 bit data (1:0000 0001 - 255:1111 1111) are divided into top 4 bits and 4 bits of low ranks, and are changed into ASCII data.

(2): Data from which high 4 bits is converted into ASCII.

(3): Data from which low 4 bits is converted into ASCII.

c: Sub address [(4): single-digit]

- It is being fixed to (4) =1 (31H), because MAC3 is single loop equipment.
- When other addresses are appointed, it gives no response as sub address error.

(3) Details of Basic format part II

h: Text end character (12): single-digit / ETX (03H), or ":" (3AH)]

- It shows that the text part has just finished.

i: BCC data [(13) (14):double-digit]

- BCC data checks communication data's abnormality.
- When BCC error is shown as a result of BCC operation, it gives no response.
- There are the four following types of BCC operations.
(BCC operation type can be set up by 4-6. **Setup of BCC Operation Type**)

1) None

BCC operation is not performed. (13) and (14) are omitted.

2) Addition

Addition operation is performed in the unit of ASCII data 1 character (1 byte), from start character (1) to text end character (12).

3) Addition + Complement of 2

Addition operation is performed in the unit of ASCII data 1 character (1 byte), from start character (1) to text end character (12). From the operation result, low rank 1 byte's complement of 2 is taken.

4) Exclusive OR

XOR (exclusive OR) operation is performed in the unit of ASCII data 1 character (1 byte), from immediately after start character < equipment address (2) >to text end character (12). .

- Regardless of data bit length (7 or 8), calculate in the unit of 1 byte (8 bits).

- According to the above-mentioned operation result, the low rank 1 byte data is divided into top rank 4 bits and 4 bits of low rank, and is changed into ASCII data.

(13): Data from which high 4 bits is converted into ASCII.

(14): Data from which low 4 bits is converted into ASCII.

Example 1: BCC At setup of Addition at the time of Read command (R).

(1)	(2)	(3)	(4)	(5)	(6)	(7)	(8)	(9)	(10)	(12)	(13)	(14)	(15)
STX	0	1	1	R	0	1	0	0	0	ETX	D	A	CR

$$02H + 30H + 31H + 31H + 52H + 30H + 31H + 30H + 30H + 30H + 03H = 1DAH$$

Addition result (1DAH)'s low 1 byte = DAH

(13) : "D" = 44H , (14) : "A" = 41H

Example 2 : BCC At setup of Addition + Complement of 2 at the time of Read command (R)

(1)	(2)	(3)	(4)	(5)	(6)	(7)	(8)	(9)	(10)	(12)	(13)	(14)	(15)
STX	0	1	1	R	0	1	0	0	0	ETX	2	6	CR

$$02H + 30H + 31H + 31H + 52H + 30H + 31H + 30H + 30H + 30H + 03H = 1DAH$$

Addition result's (1 DAH) low rank 1 byte = DAH

Complement of 2 low 1 byte (DAH) = 26

(13) : "2" = 32H , (14) : "6" = 36H

Example 3: BCC At Exclusive OR setup at the time of Read command (R).

(1)	(2)	(3)	(4)	(5)	(6)	(7)	(8)	(9)	(10)	(12)	(13)	(14)	(15)
STX	0	1	1	R	0	1	0	0	0	ETX	5	0	CR

$$30H \oplus 31H \oplus 31H \oplus 52H \oplus 30H \oplus 31H \oplus 30H \oplus 30H \oplus 30H \oplus 03H = 50H$$

- = XOR (exclusive OR)

low rank 1 byte of operation result (50H) = 50H

(13) : "5" = 35H , (14) : "0" = 30H

j: End character (delimiter) [(15): single-digit / CR]

- This shows the end of communication.

(4) Basic format part I, II Common conditions

- 1) When the following abnormalities have been recognized in the basic format part, no answer is given.
 - when there happened hardware error. (overrun, flaming, parity error)
 - when equipment address and sub address differ from the address of appointed equipment.
 - when character is not in the proper position that determined in the above-mentioned communication format.
 - when the operation result of BCC differs from BCC data.
- 2) Binary digit (binary) data is converted into ASCII data every 4 bits.
- 3) In a hexadecimal number, <A>~<F> are converted into ASCII data using a capital letter.

(5) Text part outline

Text part changes with the type of command, and communication responses.

See **5-3. Read command (R) details** as well as **5-4. Write command (W) details** about details of text part.

d: Command type [(5):single-digit],

- "R" (52H/capital letter): This shows that they are read command and read command response.
Used when various data are read out (or read in) to a personal computer, PLC, etc.
- "W" (57H/capital letter): This shows that they are write command and write command response.
Used when various data are written in (or changed) from a personal computer, PLC, etc.
- On occasions when unusual characters other than "R" and "W" have been recognized, it gives no response.

e: Lead data address [(6), (7), (8), (9): four-digit]

- At the time of a Read command (R) and a Write command (W), read-out and the lead data address of writing place is appointed.
- Lead data address is appointed as binary digit data of 16 bits (1 word /0~65535).
- 16 bit data are divided every 4 bits, and are converted into ASCII data.

binary digit (16 bits)	D15,D14,D13,D12	D11,D10, D9, D8	D7, D6, D5, D4	D3, D2, D1, D0
	0 0 0 0	0 0 0 1	1 0 0 0	1 1 0 0
hexadecimal number	0 H	1 H	8 H	C H
	"0"	"1"	"8"	"C"
ASCII data	3 0 H	3 1 H	3 8 H	4 3 H
	(6)	(7)	(8)	(9)

- See **8. Communication Data Address List** about data address

f: The number of data [(10): single-digit]

- At the time of a Read command (R) and a Write command (W), the numbers of read-out and write-in data are appointed.
- The number of data is appointed by converting binary digit 4 bit data into ASCII data.
- At the time of a Read command (R), it is possible to appoint in the following range.
"0"(30H) (one) ~ "9" (39H) (ten)
- Being fixed to "0" (30H) (one) at the time of Write command (W).
- The actual number of data is < the number of data =appointed data value + 1 >

g: Data [(11): the number of digit is determined by data number]

- Write-in data at the time of Write command (W) (changed data) as well as the read-out data at the time of Read command (R) response are appointed.
- The data format is as follows.

g (11)

	1st data				2nd data				n-th data			
	high			lower	high			lower	hige			lower
	1	2	3	4	1	2	3	4	1	2	3	4
", " 2CH												

- Quotation ("," "2CH) are, without fail, added to the head of data, and subsequent portion is data.
- The sign which divides between data and data is not employed.
- The number of data is determined with the number of data of communication command format f:(10).
- One data is expressed in the unit of binary digit, 16 bits (1 word) except decimal point.
- The positions of a decimal point differ from data to data.
- 16 bit data are divided every 4 bits, and each is converted into ASCII data.
- See **5-3. Read Command (R) Details**,and **5-4. Write Command (W) Details** about the details of data

e: Answering code [(6), (7):double-digit]

- Appointment of the answering code to Read command (R) and Write command (W).
- Binary digit 8 bit data (0~255) are divided into high rank 4 bits and low rank 4 bits, and each is converted into ASCII data.
 - (6): Data from which high 4 bits is converted into ASCII.
 - (7): Data from which low 4 bits is converted into ASCII.
- In the case of normal response, "0" (30H) and "0" (30H) are appointed.
- In the case of abnormal response, abnormal code NO. is converted to ASCII data and appointed.
- See **5-5. Answering Code Details** about details of answering code.

5-3. Read command (R) Details

Read command (R) is used when it reads in (take in) various data from a personal computer, PLC, etc.

(1) Read command (R) format

- Text part format at the time of Read command (R) is as follows.
- (Basic format part I and II are common to all the commands and responses.)

text part					
d	e				f
(5)	(6)	(7)	(8)	(9)	(10)
R	0	4	0	0	4
52H	30H	34H	30H	30H	34H

d: this means Read command.

e: lead data address of read-out data is appointed.

f: appointment of the number of data that should be read out of lead data address.

- The above-mentioned command is as follows.

read-out lead data address = 0400H (hexadecimal number)
 = 0000 0100 0000 0000 (binary digit)

the number of read-out data = 4H (hexadecimal number)
 = 0100 (binary digit)
 = 4 (decimal number)

(the actual number of data) = 5 (4+1)

Namely, read-out of five data from the data address 0400H is being appointed.

(2) The normal response format at the time of Read command (R)

- The normal response format (text part) to Read command (R) is as follows.
- (Basic format part I and II are common to all the commands and responses.)

text part															
d	e		g												
(5)	(6)	(7)	(11)												
R	0	0	1st data				2nd data				5 th data				
52H	30H	30H	2CH	30H	30H	31H	45H	30H	30H	37H	38H	30H	30H	30H	33H

- d (5) : <R (52H)> which shows that it is the response of Read command (R) is inserted.

- e (6),(7) : <00 (30H, 30H) >, which shows the normal response of Read command (R), is inserted.

- g (11) : The response data of Read command (R) is inserted.
The format of data is as follows.
 1. At first, <, (2CH) >, which shows the head of data, is inserted.
 2. Next, from <the data of read-out lead data address>, the same number of data as <the number of read-out data> is inserted in order.
 3. Nothing is inserted between data.
 4. One data consists of binary digit data, 16 bits (1 word) except a decimal point.
Data is converted into ASCII data every 4 bits and inserted.
 5. The positions of a decimal point differ from data to data.
 6. The number of characters of response data is as follows.
the number of character = 1 + 4 × the number of read-out data

- The following data is answered as response data, in order, to the above-mentioned Read command (R).

lead of read-out data address		data address		data	
		16 bits (1 word)		16 bits (1 word)	
		hexadecimal number	hexadecimal number	decimal number	
(0400H)	→	0	0400	001E	30
		1	0401	0078	120
		2	0402	001E	30
		3	0403	0000	0
		4	0404	0005	5

number of read-out data (4H : 5)

(3) The abnormal response format at the time of Read Command (R)

- The abnormal response format (text part) to Read command (R) is as follows.
(Basic format part I and II are common to all the commands and responses.)

text part

d	e	
(5)	(6)	(7)
R	0	7
52H	30H	37H

- d (5): <R (52H) >, which shows the answer of read command, is inserted.
- e (6), (7): answering code, which shows abnormal response of Read command (R), is inserted.
- See **5-5. Answering Code Details** about the details of abnormal code.
- Response data is not inserted in abnormal response.

5-4. Write Command (W) Details

Write command (W) is used when various data is written in (or changed) from a personal computer, PLC, etc.

1) Write command (W) format

-The text part format at the time of the Write command (W) is as follows.
 (Basic format part I and II are common to all the commands and responses.)

text part										
d	e				f	g				
(5)	(6)	(7)	(8)	(9)	(10)	(11)				
W	0	4	0	0	0	write-in data				
57H	30H	34H	30H	30H	30H	,	0	0	2	8
						2CH	30H	30H	32H	38H

- d: This shows Write command. It is being fixed as "W" (57H).
- e: The lead data address of Write-in (change) data is appointed.
- f: The number of write-in (change) data is appointed.
 The number of write-in data is fixed as "0" (30H) One.
- g: Write-in (change) data is appointed.
 1. <, (2CH) >, which shows the lead of data, is inserted.
 2. Next, write-in data is inserted.
 3. Data consists of binary digit data,16 bits (1 word) except a decimal point, and it is converted into ASCII data every 4 bits, and inserted.
 4. The positions of a decimal point differ from data to data.

- The above-mentioned command is as follows.

Write-in lead data address = 0400H (hexadecimal number)
 = 0000 0100 0000 0000 (binary digit)

The number of write-in data = 0H (hexadecimal number)
 = 0000 (binary digit)
 = 0 (decimal number)

(the actual number of data) = One (0+1)
 Write-in data = 0028 (hexadecimal number)
 = 0000 0000 0010 1000 (binary digit)
 = 40 (decimal number)

Data address 0400H, write-in (change) of one data (40: decimal number) is appointed.

data address		data	
16 bits (1 word)		16 bits (1 word)	
hexa- decimal number	decimal number	hexa- decimal number	decimal number
0400	1024	0028	40
0401	1025	0078	120
0402	1026	001E	30

address(400H) → 0
 the number of write-in data
 One(0 1)

(2) The normal response format at the time of W0rite command (W)

- The normal response format (text part) to Write command (W) is as follows.
 (Basic format part I and II are common to all the commands and responses.)

text part		
d	e	
(5)	(6)	(7)
W	0	0
57H	30H	30H

- d (5) : <W (57H)>, which shows response of Write command (W), is inserted.
- e (6), (7): <00 (30H, 30H)>, which shows normal response of Write command (W), is inserted.

- (3) The abnormal answer format at the time of Write Command (W)
- The abnormal answer format (text part) to a Write Command (W) is as follows.
(Basic format part I and II are common to all the commands and responses.)

text part		
d	e	
(5)	(6)	(7)
W	0	9
57H	30H	39H

- d (5) : <W (57H)>, which shows answer of Write command (W), is inserted.
- e (6), (7) : Abnormal response, which shows abnormal answer of Write command (W), is inserted.
- See **5-5. Answering Code Details** about details of abnormal code.

5-5. Answering Code Details

- 1) The type of answering code
- The communication answer to Read command (R) and Write command (W) always contains the answering code.
 - An answering code is roughly divided into two kinds.

Answering code { Normal answering code
Abnormal answering code

- Answering code consists of binary digit, 8 bit data (0~255).
- The type of answering code is as follows.

Answering Code List

answering code		code type	content of code
binary	ASCII		
0000 0000	"0", "0" : 30H, 30H	normal answer	- Normal answering code
0000 0111	"0","7" : 30H,37H	Format error of text part	- when number other than 0~9 is appointed as the number of data - when ones other than 0~9 and A~F are included - when quotation ", "are not given to the appointed position
0000 1000	"0","8" : 30H,38H	Data address Error in the number of data	- when non-existing address is appointed - when read-only is written - when write-only is read - when numbers other than zero are appointed as the number of data, at the time of W command
0000 1001	"0","9" : 30H,39H	Data error	- when the write-in data exceeds the settable range
0000 1010	"0","A" : 30H,41H	Execution command error	- when execution command is received in the unsuitable state (when rewriting of RUN/STBY is performed even though RUN/STBY is assigned to DI)
0000 1011	"0","B" : 30H,42H	Write mode error	- when write command is received under circumstances where data rewriting is impossible (such case as rewriting of manual output value is performed during AUTO execution)
0000 1100	"0","C" : 30H,43H	Specification option error	- when the write command which contains unlisted specification or option's data is received

- (2) The priority of answering code
- As the value of answering code becomes low, the priority of answering code becomes high.
When plural answering codes occur, the high priority answering code is returned.

5-6. Communication Data Address Details

1) Data address

- As for a data address, a binary digit (16 bit data) is expressed with a hexadecimal number every 4 bits.

2) About read-out (read)/write-in (write).

- R/W is the data in which read-out and writing are possible

- R is read-only data.

- W is data only for writing.

- When the data address only for writing is appointed in Read command (R),

and read-only data address is appointed in Write command (W), data address error is shown.

And abnormal answering code, ="0" , "8" (30H, 38H), "data format of text part, data address, and errors in the number of data" ,is answered.

3) Data address and the number of data

- When the data address, which is not listed in data address, is appointed as lead data address, data address error is shown. And abnormal answering code, ="0" , "8" (30H, 38H), "data format of text part, data address, and errors in the number of data", is answered.

- When the data address, to which the number of data is added, becomes outside of listed data address, in the area of outside-address, "0000 H" (30H, 30H, 30H, 30H) is answered always as data.

4) Data

- Since each data does not have a decimal point (16 bit data), the check of data type and decimal point is needed.

(See instruction manual of main body)

- In the case of the data whose unit is UNIT, measuring range determines the position of decimal point.

- All the data is treated as binary digit with a code (16 bit data: -32768 ~ 32767).

Example: Method to express data with a decimal point

		hexadecimal number		
20.0	→	200	→	00C8
100.00	→	10000	→	2710
-40.00	→	-4000	→	F060

Example: Method to express 16 bit data

data with code	
decimal number	hexadecimal number
0	0000
1	0001
≈	≈
32767	7FFF
-32768	8000
-32767	8001
≈	≈
-2	FFFE
-1	FFFF

5) Option-related parameter

- When the data address of parameter, which is not listed as an option, is appointed, the abnormal answering code , "0", "C" (30H, 43H) "specification, option error", is answered to Read command (R) and Write command (W).

6) The parameter which is not displayed in an operator display because of operation specification or setting specification

- The parameter, which is not displayed (not used) in an operator display because of operation specification or setup specification, is possible to read-out in communication.

However, in write-in, the abnormal answering code,"0" ,"B" (30H, 42H) "write mode error", is answered.

6. Outline of MODBUS Communication Protocol

MODBUS has two kinds of modes or RTU mode and ASCII mode, and according to the setting content of **4-6. Setup of BCC Operation Type**, it changes automatically.

Comparison of RTU and ASCII mode

Item	RTU	ASCII
transmission code	binary 8 bits	ASCII
error-checking	CRC-16	LRC
start bit	1 bit	
data length	8 bits	7 bits / 8 bits
parity bit	none / even number / odd number	
stop bit	CRC-16	LRC
start character	none	":"(3AH)
end character	none	CR(0DH)+LF(0AH)
time interval of data	below time to be equivalent to 28 bits	one second or less

6-1. Communication Procedure

1) Relation between master and slave

- A personal computer and PLC (host) side is master side.
- MAC3 is slave side.
- Communication is started by communication command from master side, and completed by communication answer from slave side.

However, a communication answer is not performed when abnormalities, such as communication format error or BCC error etc., have been recognized.

2) Communication procedure

The slave side answers the master side, a transmitting right is transferred by turns, and a communication procedure is performed.

3) Communication data

RTU mode is 8-bit binary transmission.

In ASCII mode, 8-bit binary of RTU is converted to the two-letter ASCII code and transmitted.

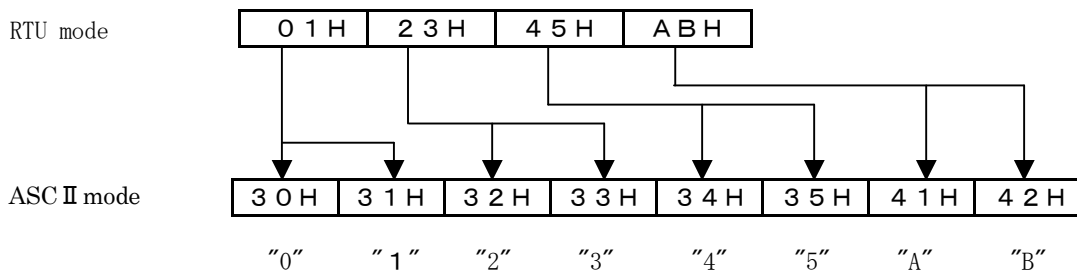

4) Message frame composition

RTU mode consists of only messages.

ASCII mode consists of start character ":" (3AH) + message + end character, CR (0DH) + LF (0AH).

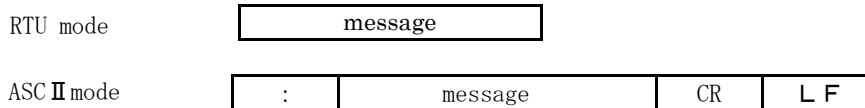

5) Timeout

- RTU mode

When message stops during time equivalent to 28 bits, it is regarded as the end of message.

When a blank arises during time equivalent to 28 bits in the middle of message transmitting, it is judged as the end of message. It is an imperfect message, therefore slave performs no response.

* Reference: time equivalent to 28 bits (unit = msec)

1200bps:23.4 2400bps:11.7 4800bps:5.9 9600bps:3.0 19200bps:1.5 38400bps:0.8

- ASCII mode

After receiving start character, it results in timeout when reception of end character is not completed within 1 second. And it waits for the other command (new start character).

6-2. Communication Format

1) Composition of message

The MODBUS message has the following composition in RTU and ASC II mode.

All the message components are treated not by a decimal number but by a hexadecimal number.

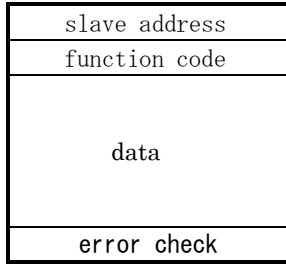

2) Communication command format (MODBUS: Described by RTU because RTU is foundation)

- As for the message from master, message length is being fixed regardless of the function code.

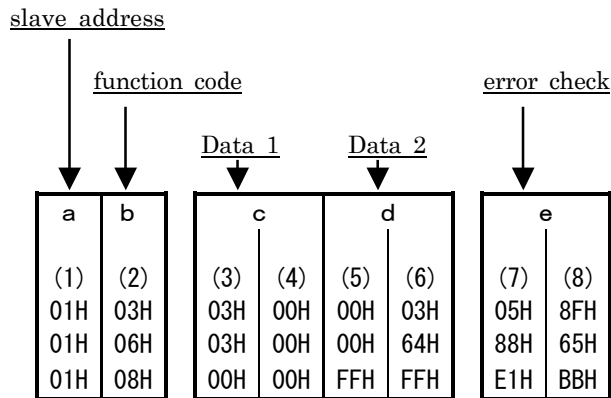

3) Communication answer format (MODBUS: Described by RTU because RTU is foundations)

- The answer from a slave differs in message length along with a function code.

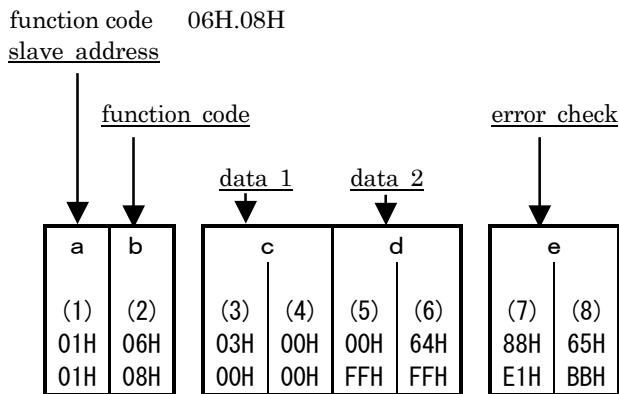
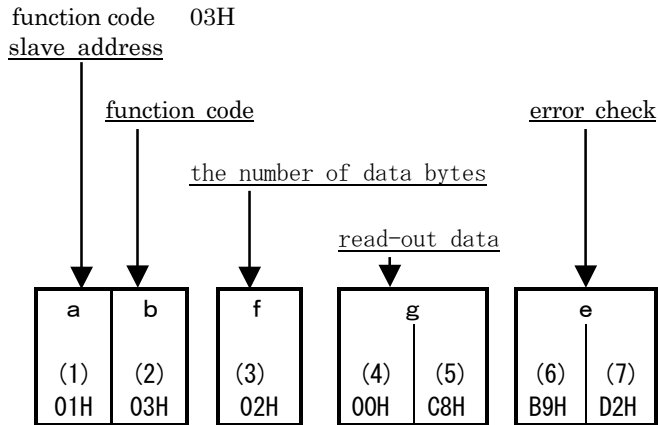

a: Slave address

- The message which the master sent is received by all the connected equipment. Only the slave congruous with message's slave address answers the message.

- In MAC3, 1~255 (01 H~FFH) can be appointed as slave address.

Note: In MODBUS specification, address which can be appointed to slave is 1~247 (01 H~F 7H)

b: Function code

- A code number shows the function to perform.

function code	function
0 3 H	data read-out
0 6 H	data writing
0 8 H	loopback test

c: Data 1

- Composition of data differs along with function code.

d: Data 2

- Composition of data differs along with function code.

function code	data 1 content	data 2 content
0 3 H	data address	the number of read-out
0 6 H	data address	write-in data
0 8 H	fixed as 0000H	arbitrary data

e: Error checking

- Error-checking system differs along with MODBUS mode.

RTU mode : CRC-16

ASC II mode : LRC

- See **6-3. Error Checking** about details concerning error checking.

f: The number of data bytes

- The number of read-out data bytes at the time of data read-out.

- Read-out demand is word unit; therefore it is twice of the number of read-out.

the number of read-out		the number of data bytes	
decimal number	hexa-decimal number	decimal number	hexa-decimal number
1	01H	2	02H
2	02H	4	04H
3	03H	6	06H
4	04H	8	08H
5	05H	10	0AH
6	06H	12	0CH
7	07H	14	0EH
8	08H	16	10H
9	09H	18	12H
10	0AH	20	14H

g: Read-out data

- The data along with read-out demand is inserted.

- Along with the number of read-out, data length varies and there is no data breaking.

The number of read-out is: 1 = 2 bytes, 3 = 6 bytes, and 10 = 20 bytes.

6-3. Error Checking

Error checking is calculated by the sending side and the result is attached to the end of outgoing message.

Error checking of incoming message is calculated by the reception side.

The result is checked if it is the same as received error checking.

If the check results met, incoming message is judged to be right, and answer operation to reception is started.

If it differs, data is judged as abnormal, and slave performs no response.

(1) CRC-16

CRC-16 is 2 bytes (16 bits) of error-checking code.

CRC-16 is calculated in the following procedures from slave address to the end of data.

1. to initialize CRC register by FFFFH.
2. Exclusive OR with CRC register and the first 1 byte of message.
A calculation result is written in CRC register.
3. Shift 1 bit of CRC registers to the right.
4. If carry fragment (shift-out bit) is 1, exclusive OR with CRC register and A001H.
The calculation result is written in CRC register.
5. Repeat 3. and 4. until it shifts eight times.
6. Exclusive OR with CRC register and 1 byte next to message.
The calculation result is written in CRC register.
7. 3.~ 6. is repeated to all the data except CRC.
8. Data byte is calculated to the end. The computed CRC register value is assigned to a message in order of low rank and high rank.

(2) LRC

LRC calculates from slave address to the end of data in the following procedures.

(Note: LRC calculation is performed by RTU binary, the antecedent method of ASCII binary)

1. Addition, from the lead of data (slave address) to the end, is carried out.
When a calculation result exceeds FFH, the value beyond 100H is omitted. (153H is treated as 53H)
2. The complement of addition's result (bit reversal) is taken, and 1 is added to the result.
3. The above-mentioned value works as the LRC code.
4. The LRC code is assigned to the end of message, and the whole is converted into the ASCII character.

6-4. Data Read-out (Function Code 03H) Details

Function code 03H is used on occasions when it reads (takes in) various data from a personal computer, PLC, etc.

(1) Data read-out format

- The format at the time of data read-out is as follows.

a	b			c	d			e	error checking in ASCII mode the portion of (7), (8) is as follows LRC:F5H
(1)	(2)	(3)	(4)	(5)	(6)	(7)	(8)		
01H	03H	04H	00H	00H	03H	04H	FBH		

- a: Slave address
- b: Data read-out function code
- c: Read-out lead data address
- d: The number of read-out data from lead data address

* The numbers of data which can be read is 1~10.

Therefore, binary code permitted here is 0001H~000AH, and error code is returned if value other than the above is appointed.

e: Error checking

- The above-mentioned command is as follows.

Read-out lead data address = 0400H (hexadecimal number)
 The number of read-out data = 0003H (hexadecimal number)
 Three data read-out is appointed from data address 0400H

(2) The normal answer format at the time of data read-out

- The normal answer format to function code 03H is as follows.

a	b			f	g						e	error checking in ASCII mode the portion of (10), (11) is as follow LRC:42H	
(1)	(2)	(3)	0400H		(4)	(5)	(6)	(7)	(8)	(9)	(10)		(11)
01H	03H	06H	00H	1EH	00H	78H	00H	1EH	00H	1EH	89H		66H

- a: Slave address
- b: Function code
- f: The number of read-out data bytes

* three data read-out, so 6 bytes read-out. Therefore, it is 06H.

g: Read-out data

1. The same number of data as that of read-out data is inserted from read-out's data of lead data address, in order.
2. Nothing is inserted between data.
3. One data consists of binary digit 16 bits data(1 word) except for a decimal point.
4. Each data has position of peculiar decimal point.

e: Error checking

read-out lead data address	data address		data	
	16 bits (1 word)	hexadecimal number	hexadecimal number	decimal number
(0400H) →	1	0400	001E	30
number of read-out data (0003H : 3)	2	0401	0078	120
	3	0402	001E	30

(3) The abnormal answer format at the time of data read-out

a	b			h			e	error checking at the time of the ASCII mode the portion of (4), (5) is as follow LRC: 79H
(1)	(2)	(3)	(4)	(5)				
01H	83H	03H	01H	31H				

- a: Slave address
- b: Function code
- * At the time of error, reception function code +80H is shown. It informs abnormal answer.
- h: Error code
- * See **6-8. Error Message Details** about details of error code.
- e: Error checking

6-5. Data Write-in (Function Code 06H) Details

Function code 06H is used on occasions when it writes in (changes) various data from a personal computer, PLC, etc.

(1) Data write-in format

- The format at the time of data writing is as follows.

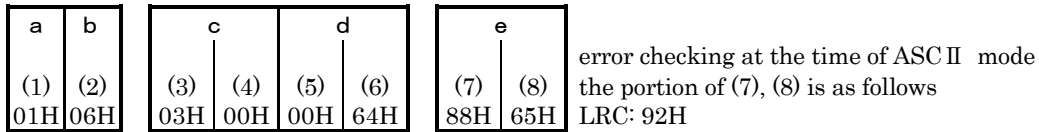

a: Slave address

b: Data write-in function code

c: A write-in data address

d: Write-in data

1. Data consists of binary digit 16 bits data (1 word) except for a decimal point.
2. Each data has position of peculiar decimal point.

e: Error checking

- The above-mentioned command is as follows.

write-in lead data address = 0300H (hexadecimal number)
write-in data = 0064H (hexadecimal number)
= 100 (decimal number)

Writing of the data addresses, 0300H (100:10 decimal numbers), is appointed.

	data address 16 bits (1 word)		data 16 bits (1 word)	
	hexadecimal number	hexadecimal number	hexadecimal number	decimal number
address (0300H) →	0300	0064	100	
write-in data (0064H)	0301	0000	0	
	0302	0000	0	

(2) The normal answer format at the time of data writing

- The normal answering format to function code 06H is as follows.

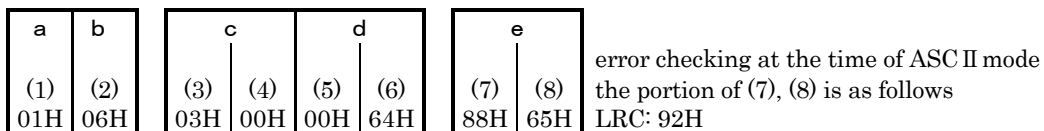

* The same one as the outgoing message from master is answered.

(3) The abnormal answer format at the time of data writing

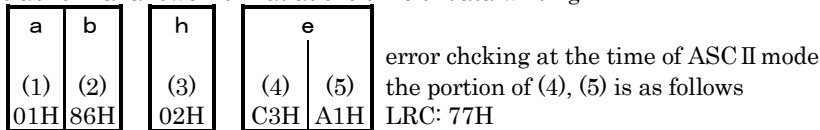

a: Slave address

b: Function code

* At the time of error, reception function code +80H is shown. It informs abnormal answer.

h: Error code

* See **6-8. Error Message Details** about error code details.

e: Error checking

6-6. Loopback Test (Function Code 08H) Details

The function code 08H returns the message from master as response message as it is. It is used as communication diagnosis between master and slave.

(1) Loopback format

- The format at the time of a loopback test is as follows.

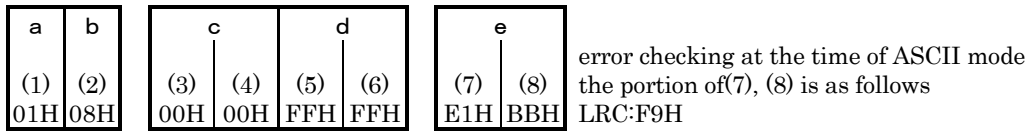

- a: Slave address
- b: Data write-in function code
- c: Test code
 - * Fixed as 0000H
- d: Arbitrary data
 - * arbitrary 16 bit data of 0000H~FFFFH
- e: Error checking

(2) Loopback normal answer format

- The normal answer format to the function code 08H is as follows.

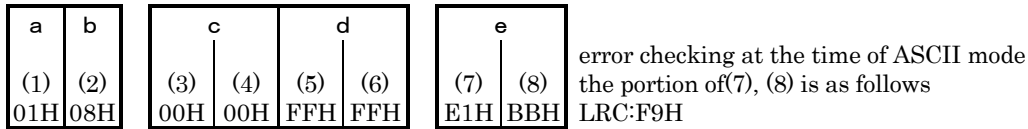

* The same one as the outgoing message from master is answered.

(3) The abnormal answer format at the time of loopback

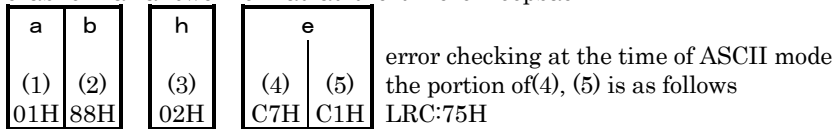

- a: Slave address
- b: Function code
 - * At the time of error, reception function code +80H is shown. It informs abnormal answer.
- h: Error code
 - * See **6-8. Error Message Details** about error code details.
- e: Error checking

6-7. No Response Conditions

Slave does not answer when the following abnormalities have been recognized.

- when hardware error takes place (overrun, framing, parity error)
- when slave address differs from its own address
- when the data interval of message is long.
(RTU: time to be equivalent to 28 bits or more ASCII: one second or longer)
- when CRC-16 or LRC differs.
- when the message from master is not regulated one (Message is too long etc.,)

6-8. Error Message Details

Error code corresponding to the type of error is answered, when error other than no response condition is detected.

(1) Abnormal answer format

a	b
(1)	(2)
01H	83H

h
(3)
03H

e
(4) (5)
01H 31H

error checking at the time of ASC II mode
the portion of (4), (5) is as follows
LRC:79H

a: Slave address

b: Function code

1. At the time of error, reception function code +80H is shown. It informs abnormal answer.
2. +80H is not shown at the time of function code beyond 80H, and returned as it is.

h: Error code

* See the following table.

e: Error checking

Error Code	Content of Errors
0 1 H	Function code error - when function code other than regulated one is received (All other than three sorts, < 03H, 06H, 08H>, correspond to this category)
0 2 H	Address error - when it is written in the address only for reading - when the address only for writing is read - when a test code is not 0000H at the time of loopback test - when non-existing address is appointed in the lead of read-out or write-in address. (not yet added option etc. is included)
0 3 H	Data error - when write-in data exceeds the writable data range (when ones other than 0 and 1 are written in AUTO/MANU switching etc.) - when the written-in value had been already filled by other one, in the item only for an exclusion setup (DI corresponds to this) - when the number of read-out data and the number possible to read-out is different. (In MAC3, read-out is permitted between 1~10.) An error code is answered when read-out is 0, or over 11. - when the number of read-out data and the number possible to read-out is different. (In MAC3, read-out is permitted between 1~10.) - when parameter is rewritten under circumstances a change is not permitted (Items such as: at the time of change by key operation, a screen displays nothing or a change is impossible)

(2) The priority of error code

The priority of error code becomes high as the value of error code becomes small. On occasions when plural error codes occur, the high priority error code is returned.

Example: Even if there are data error and address errors, 01H is returned when function code error is detected.

6-9. Communication Data Address Details

- (1) Data address
 - As for data address, binary digit (16 bit data) is expressed with hexadecimal number every 4 bits.
- (2) About read-out (read)/write-in (write).
 - R/W is the data in which read-out and writing are possible
 - R is read-only data
 - W is data only for writing.
 - when the data address only for writing is appointed in data read-in (Function code 03H),
 - when the read-only data address is appointed in data write-in (Function code 06H), it becomes address error and error code 02H is answered.
- (3) Data address and the number of data
 - When the data address, which is not described in data address, is appointed as lead data address, it becomes address error and error code 02H is answered.
 - When the data address, to which the number of data is added, becomes outside of listed data address, in the area of outside-address, as data 0000 H is answered always.
- (4) Data
 - Since each data does not have a decimal point (16 bit data), the check of data type and decimal point is needed.
(See the instruction manual of main body)
 - In the case of the data whose unit is UNIT, measuring range determines the position of a decimal point.
 - All the data is treated as binary digit with a code (16 bit data: -32768 ~ 32767).

Example: Method to express data with a decimal point

Hexadecimal data

20.0 → 200 → 00C8
 100.00 → 10000 → 2710
 -40.00 → -4000 → F060

Example: Method to express 16 bit data

data with code	
decimal number	hexadecimal number
0	0000
1	0001
≈	≈
32767	7FFF
-32768	8000
-32767	8001
≈	≈
-2	FFFE
-1	FFFF

- (5) An option-related parameter
 - When the data address of the parameter, which is not listed as an option, is appointed, it results in an error both at Read command (R) and Write command (W). And error code 02H is answered
- (6) The parameter which is not displayed in an operator display because of operation specification or setting specification
 - The parameter, which is not displayed (not used) in an operator display because of operation specification and setup specification, is possible to read-out in communication.
However, write-in becomes data error and error code 03H is answered.

7. Communication Master Mode Outline

In 5. Standard Serial Communications Protocol Outline and 6. MODBUS Communications Protocol Outline, MAC3 is explained on the assumption that it mainly works as the slave side.

If master mode (**RST**) is chosen in slave address setup, MAC3 operates as the master side which transmits SV value to the slave side.

7-1. Master/Slave Connection

[RS-485]

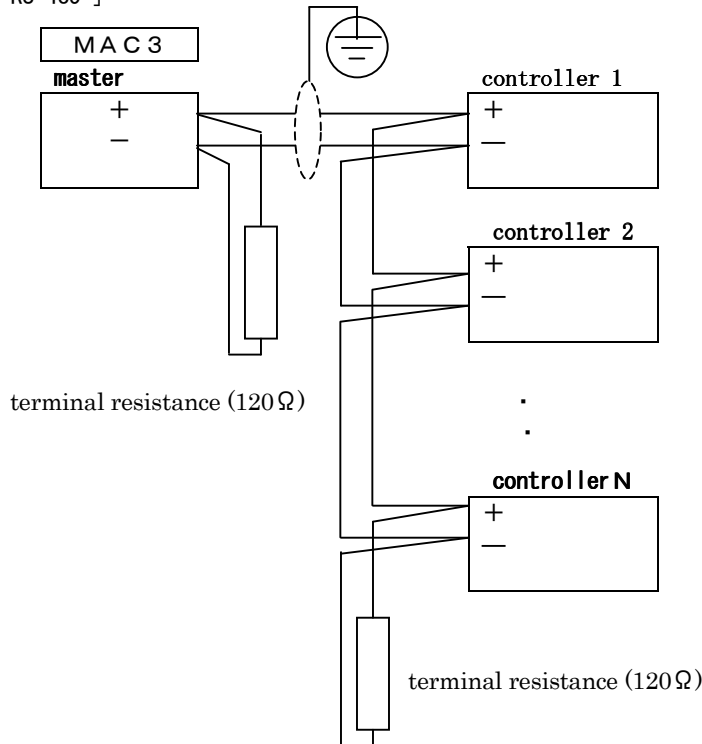

	MAC3 terminal number	
	MAC3A,MAC3B	MAC3D
+	[23]	[17]
-	[24]	[18]

- Note 1: Use MAC3 by attaching terminal resistance of 1/2W 120Ω, between one master and one end terminal (between + and -)
Operation cannot be guaranteed on occasions when terminal resistance is attached to the other point.
- Note 2: Be sure to perform wiring with a shielding wire and to connect one side of shield to the ground.
A customer needs to take measures against a lightning surge, when wiring by shielding wire cannot be performed.
- Note 3: Use only one master in one communication loop.
Operation in the case of using two or more sets of master cannot be guaranteed.

7-2. Communication Details

(1) Transmit data from master

SV data corresponding to master mode setup is transmitted to the equipment of start~end slave address. Next, it is written in the address set up in the write-in data address.

(2) Communications protocol

It follows the communications protocol set up by BCC operation type.

(3) Delay time

After data is received from slave and delay time standby is performed, the following data is transmitted from master.

(4) Timeout

When normal answer data is not received even if it passes for 1 second after data is transmitted from master, data is transmitted to the next slave address.

(5) SV value to be transmitted

When SV value constantly changes in programming operation, and there are many slaves, slave side may take nonequivalent values if rewriting of all the slaves do not finish within SV renewal period (250Ω).

(6) Transmit data at the time of STBY (RST)

In the RST state in PROG mode, the start SV value is transmitted at the time of master mode SV.

In the STBY state in FIX mode, the present SV value is transmitted at the time of master mode SV.

(Measuring range lowest limit value is transmitted at master mode OUT 1, OUT 2)

Note: In both RUN and STBY state in FIX mode, the same data is sent at the time of master mode SV.

8. Communication Data Address List

data Addr. (Hex)	Setting range	R/W
0040	Series Code 1 "M","A" 4DH,41H	R
0041	Series Code 2 "C","3" 43H,33H	R
0042	Series Code 3 Equipment Size (See the following parts)	R
0043	Series Code 4 Input Specification + Control Output 1 (See the following parts)	R

- The above-mentioned address domain is the data area of product ID.

Data is 8-bit unit ASCII data. Therefore, two data is expressed with a single address.

- The series code is expressed by a maximum of 8 data, and 0 is inserted in an extra domain.

equipment size	address		input SPEC	output SPEC	address	
	0042H				0043H	
96×96	"A","0"	41H,30H	M		"M" 4DH	
48×96	"A","0"	41H,30H	V		"V" 56H	
48×48	"D","0"	44H,30H	I		"I" 49H	
				C		"C" 43H
				S		"S" 53H
				I		"I" 49H

* Because 96×96 and 48×96 do not have a difference as equipment specification "A" is returned.

0044	software version code 1	R
0045	software version code 2	R

- The above-mentioned address domain is that of software version. Data is 8-bit unit ASCII data. Therefore, two data is expressed with a single address.

- Software version is expressed with four-digits and a decimal point is placed between data address 0044 and 0045.

Example: Version 1.00 Address H L H L
 0044 "0","1" 30H, 31H
 0045 "0","0" 30H, 30H

0046	option code 1 event output + control output 2 & event output & DI	R
0047	option code 2 DI + CT input	R
0048	option code 3 analog output + communication	R
0049	option code 4 program	R

- The above-mentioned address domain is the data area of product ID. Data is ASCII data of 8-bit unit. Therefore, two data is expressed with a single address.

- An option code is expressed by a maximum of 8 data, and 0 is inserted in an extra domain.

event	control output 2 others	address		D I	CT input	address	
		0046H				0047H	
N		"N" 4EH		N		"N" 4EH	
E		"E" 45H		D		"D" 44H	
	N		"N" 4EH		N		"N" 4EH
	C		"C" 43H		H		"H" 48H
	S		"S" 53H				
	I		"I" 49H				
	E		"E" 45H				
	D		"D" 44H				

analog output	communication	address	
		0048H	
N		"N" 4EH	
T		"T" 54H	
	R		"R" 52H

program	address	
	0049H	
N	"N","0"	4EH,30H
P	"P","0"	50H,30H

0100	measured value	within measuring range	HHHH,CJHH,b---:7FFFH	LLLL,CJLL:8000H	R
0101	execution SV value	within SV limiter			R
0102	control output 1 value	0.0~100.0			R
0103	control output 2 value	0.0~100.0			R

data Addr. (Hex)	Setting range	R/W
0104	Operation fragment D15 D14 D13 D12 D11 D10 D9 D8 D7 D6 D5 D4 D3 D2 D1 D0 0 0 0 0 0 0 AT/W 0 0 0 0 0 0 STBY MAN AT * ON at the time of AT/W:AT standby ON at the time of STBY:STBY (RST) ON at the time of MAN : MANU ON at the time of AT : AT execution	R
0105	Event output fragment D15 D14 D13 D12 D11 D10 D9 D8 D7 D6 D5 D4 D3 D2 D1 D0 0 0 0 0 0 0 0 0 0 0 0 0 0 EV3 EV2 EV1 * ON at the time of EV 3: EV 3 LED lighting ON at the time of EV 2: EV 2 LED lighting ON at the time of EV 1: EV 1 LED lighting	R
0107	Execution PID No. D15-8 D7-0 OUT2PIDNo. OUT1PIDNo. * PID No. of control output 2 in high 8 bits PID No. of control output 1 in low 8 bits FFH if control output 2 is not equipped	R
0109	CT 1 electric current value 0.0~50.0	R
010A	CT 2 electric current value 0.0~50.0	R
010B	DI input state fragment D15 D14 D13 D12 D11 D10 D9 D8 D7 D6 D5 D4 D3 D2 D1 D0 0 0 0 0 0 0 0 0 0 0 0 0 0 D14 D13 D12 D11 * When DI 1-4 turns on, applicable bit turns on	R
010D	Latching status fragment D15 D14 D13 D12 D11 D10 D9 D8 D7 D6 D5 D4 D3 D2 D1 D0 0 0 0 0 0 0 0 0 0 0 0 0 0 0 EV3 EV2 EV1 * In latching operating state, applicable bit turns ON at the time of event retention.	R
010E	Relay ON/OFF fragment D15 D14 D13 D12 D11 D10 D9 D8 D7 D6 D5 D4 D3 D2 D1 D0 0 0 0 0 0 0 0 0 0 0 0 0 0 0 EV3 EV2 EV1 * when the contact of the event relay is closed, applicable bit is ON	R
0120	Programing operation fragment D15 D14 D13 D12 D11 D10 D9 D8 D7 D6 D5 D4 D3 D2 D1 D0 PRG 0 0 0 0 0 UP LVL DW 0 0 0 0 SKIP 0 HOLD RUN * ON at the time of PRG:PROG OFF at the time of FIX UP: ON during program is ascending LVL: ON during program flatness DW: ON during program is descending SKIP:ON at the time of SKIP execution HOLD: ON at the time of HOLD execution RUN: ON at the time of RUN	R
0123	Times of execution pattern 1~9999 * Clipped at 10000 after counting to 9999, when the number of times of execution pattern is infinite.	R
0124	Execution step No. 1~25	R
0125	Execution step time 00:01 ~ 99:59 * At the time of MMSS ,HHMM Time is expressed by a high double-digit of decimal four-digit and a low double-digit of decimal four-digit. (high double-digit 00~99, low double-digit 00~59) * At the time of HHHH, Time is expressed by a high triple-digit of decimal four-digit and a low single-digit of decimal four-digit. (high triple-digit is hour; low single-digit is minute. 1 = 6 minutes) * Time count is not carried out when execution time is infinite. Therefore the fixed data of 10000 is answered.	R
0126	Execution PID No. D15-8 D7-0 OUT2PIDNo. OUT1PIDNo. * PID No. of control output 2 at high 8 bits PID No. of control output 2 at low 8 bits FFH if control output 2 is not equipped	R
0133	The number of times of remainder of execution pattern 0~9998 * When the number of times of execution pattern is infinite, the fixed data of 10000 is answered.	R

data Addr. (Hex)	Setting range			R/W
0300	FIX mode	SV 1	within SV limiter	R/W
0301	FIX mode	SV 2	within SV limiter	R/W
0302	FIX mode	SV 3	within SV limiter	R/W
0303	FIX mode	SV 4	within SV limiter	R/W
030A	SV limiter lower limit	within measuring range (input scaling lower limit~input scaling upper limit -1)		R/W
030B	SV limiter upper limit	within measuring range (SV limiter lower limit +1 ~ input scaling upper limit)		R/W
0400	OUT1-PID1	proportional band	OFF:0 0.1~999.9	R/W
0401		integration time	OFF:0 1~6000	R/W
0402		derivative time	OFF:0 1~3600	R/W
0403		manual reset	-50.0~50.0	R/W
0404		differential gap	1~999	R/W
0405		output limiter lower limit	0.0~99.9	R/W
0406		output limiter upper limit	0.1~100.0	R/W
0408	OUT1-PID2	proportional band	OFF:0 0.1~999.9	R/W
0409		integration time	OFF:0 1~6000	R/W
040A		derivative time	OFF:0 1~3600	R/W
040B		manual reset	-50.0~50.0	R/W
040C		differential gap	1~999	R/W
040D		output limiter lower limit	0.0~99.9	R/W
040E		output limiter upper limit	0.1~100.0	R/W
0410	OUT1-PID3	proportional band	OFF:0 0.1~999.9	R/W
0411		integration time	OFF:0 1~6000	R/W
0412		derivative time	OFF:0 1~3600	R/W
0413		manual reset	-50.0~50.0	R/W
0414		differential gap	1~999	R/W
0415		output limiter lower limit	0.0~99.9	R/W
0416		output limiter upper limit	0.1~100.0	R/W
0460	OUT2-PID1	proportional band	OFF:0 0.1~999.9	R/W
0461		integration time	OFF:0 1~6000	R/W
0462		derivative time	OFF:0 1~3600	R/W
0463		Dead band	-1999~5000	R/W
0464		differential gap	1~999	R/W
0465		output limiter lower limit	0.0~99.9	R/W
0466		output limiter upper limit	0.1~100.0	R/W
0468	OUT2-PID2	proportional band	OFF:0 0.1~999.9	R/W
0469		integration time	OFF:0 1~6000	R/W
046A		derivative time	OFF:0 1~3600	R/W
046B		Dead band	-1999~5000	R/W
046C		differential gap	1~999	R/W
046D		output limiter lower limit	0.0~99.9	R/W
046E		output limiter upper limit	0.1~100.0	R/W
0470	OUT2-PID3	proportional band	OFF:0 0.1~999.9	R/W
0471		integration time	OFF:0 1~6000	R/W
0472		derivative time	OFF:0 1~3600	R/W
0473		Dead band	-1999~5000	R/W
0474		differential gap	1~999	R/W
0475		output limiter lower limit	0.0~99.9	R/W
0476		output limiter upper limit	0.1~100.0	R/W

data Addr. (Hex)	Setting range						R/W	
0500		Event operation mode See <i>Event Code Table</i>					R/W	
0501	EV1	Event operating point See <i>Event Code Table</i> * At the time of SHIMAX standard protocol If event mode has unnecessary setting of NON, So, Run, Stp, P_E, End, Hold, and Prog, setting change is possible by communication. However, it is initialized at the time of event code change. The writable range in this case is -1999~9999					R/W	
0502		Event differential gap 1~ 999					R/W	
0503		Event standby operation OFF: 0 1 ~ 2					R/W	
0505	EV1	Event latching / output characteristic D15-8 D7-0 Latching Output characteristic * ON/OFF of event latching at high 8 bits, NO/NC of output characteristic at low 8 bits Latching OFF: 0 ON: 1 Output characteristic NO: 0 NC: 1					R/W	
0508		Event operation mode See <i>Event Code Table</i>					R/W	
0509	EV2	Event Operating Point See <i>Event Code Table</i> . * At the time of SHIMAX standard protocol If event mode has unnecessary setting of NON, So, Run, Stp, P_E, End, Hold, and Prog, setting change is possible by communication. However, it is initialized at the time of event code change. The writable range in this case is -1999 ~ 9999					R/W	
050A		Event differential gap 1~999					R/W	
050B		Event standby operation OFF:0 1~2					R/W	
050D	EV2	Event latching / output characteristic D15-8 D7-0 Latching output characteristic * ON/OFF of event latching at high 8 bits, NO/NC of output characteristic at low 8 bits Latching OFF: 0 ON: 1 Output characteristic NO: 0 NC: 1					R/W	
0510		Event operation mode See <i>Event Code Table</i>					R/W	
0511	EV3	Event operating point See <i>Event Code Table</i> * At the time of SHIMAX standard protocol If event mode has unnecessary setting of NON, So, Run, Stp, P_E, End, Hold, and Prog, setting change is possible by communication. However, it is initialized at the time of event code change. The writable range in this case is -1999 ~ 9999					R/W	
0512		Event Differential Gap 1~999					R/W	
0513		Event Standby Operation OFF: 0 1~2					R/W	
0515	EV3	Event latching / output characteristic D15-8 D7-0 Latching output characteristic * ON/OFF of event latching at high 8 bits, NO/NC of output characteristic at low 8 bits Latching OFF: 0 ON: 1 Output characteristic NO: 0 NC: 1					R/W	
0580	DI 1 Mode	NON:0	SV2:1	SV3:2	SV4:3	RUN:4	PROG:5	R/W
		MAN:6	AT:7	HOLD:8	SKIP:9	L_RS:10	LOCK:11	
0581	DI 2 Mode	NON:0	SV2:1	SV3:2	SV4:3	RUN:4	PROG:5	R/W
		MAN:6	AT:7	HOLD:8	SKIP:9	L_RS:10	LOCK:11	
0582	DI 3 Mode	NON:0	SV2:1	SV3:2	SV4:3	RUN:4	PROG:5	R/W
		MAN:6	AT:7	HOLD:8	SKIP:9	L_RS:10	LOCK:11	
0583	DI 4 Mode	NON:0	SV2:1	SV3:2	SV4:3	RUN:4	PROG:5	R/W
		MAN:6	AT:7	HOLD:8	SKIP:9	L_RS:10	LOCK:11	
0595	CT 1 Delay	0.5~30.0					R/W	
0597	CT 1 Mode	NON:0	OUT1:1	OUT2:2	EV1:3	EV2:4	EV3:5	R/W
059D	CT 2 Delay	0.5~30.0					R/W	
059F	CT 2 Mode	NON:0	OUT1:1	OUT2:2	EV1:3	EV2:4	EV3:5	R/W

data Addr. (Hex)	Setting range	R/W
05A0	Analog output mode NON:0 PV:1 SV:2 OUT1:3 OUT2:4 CT1:5 CT2:6	R/W
05A1	Analog output scale lower limit PV,SV: Input scaling lower limit ~ input scaling upper limit -1 OUT 1,OUT 2:0.0~99.9 CT 1,CT 2 :0.0~49.9	R/W
05A2	Analog output scale upper limit PV,SV: analog output scale lower limit +1 ~ input scaling upper limit OUT 1,OUT 2:0.1~100.0 CT 1, CT 2 :0.1~ 50.0	R/W
05B0	Communication memory mode RAM:0 MIX:1 ROM:2	R/W
05B4	Analog output limiter lower limit 0.0~100.0	R/W
05B5	Analog output limiter upper limit 0.0~100.0	R/W
0600	Control Output 1 Output Characteristic RA:0 DA:1	R/W
0601	Control Output 1 Proportional Period 0.5~120.0 (Reception is possible only at multiple of 0.5)	R/W
0604	Control Output 2 Proportional Period 0.5~120.0 (Reception is possible only at multiple of 0.5)	R/W
0607	Control Output 2 Output Characteristic RA:0 DA:1	R/W
060A	Control output 1 soft start OFF:0 0.5~120.0 (Reception is possible only at multiple of 0.5)	R/W
060B	Control output 2 soft start OFF:0 0.5~120.0 (Reception is possible only at multiple of 0.5)	R/W
0611	Keylock OFF:0 1~3	R/W
0700	PV Gain -500~500	R/W
0701	PV Offset -500~500	R/W
0702	PV Filter 0~9999	R/W
0704	Input Temperature unit °C:0 °F: 1	R/W
0705	Measuring Range See <i>Measuring Range Code Table</i>	R/W
0707	Decimal Point Position ****:0 ***:1 **:2 *:3	R/W
0708	Input Scaling Lower Limit -1999~9989	R/W
0709	Input Scaling Upper Limit Input Scaling Lower Limit +10~9999	R/W
0800	FIX/PROG Switching FIX:0 PROG: 1	R/W
0819	Time Unit MMSS:0 HHMM: 1 HHHH: 2	R/W
0820	FIX Mode Control Output 1 SV 1 PID No. 1~3	R/W
0821	FIX Mode Control Output 1 SV 2 PID No. 1~3	R/W
0822	FIX Mode Control Output 1 SV 3 PID No. 1~3	R/W
0823	FIX Mode Control Output 1 SV 4 PID No. 1~3	R/W
0824	FIX Mode Control Output 2 SV 1 PID No. 1~3	R/W
0825	FIX Mode Control Output 2 SV 2 PID No. 1~3	R/W
0826	FIX Mode Control Output 2 SV 3 PID No. 1~3	R/W
0827	FIX Mode Control Output 2 SV 4 PID No. 1~3	R/W

data Addr. (Hex)	Setting range		R/W
0900	Reserve	Read/Write is possible, but fixed as 1.	R/W
0901	Step No.	1~25 (Regardless of memory mode, it is written only in RAM)	R/W
0903	End Step Setup	1~25	R/W
0906	Start SV	within SV Limiter	R/W
0909	Start Mode Setup	SV:0 PV:1	R/W
090C	Setup of the number of times of execution pattern	Infinity:10000	R/W
0950	Step SV Value	within SV Limiter	R/W
0951	Step Time	00:00 ~ 99:59 Infinity: 10000 (time unit MMSS, at the time of HHMM) 000.0 ~ 999.9 Infinity: 10000 (at the time of time unit HHHH)	R/W
		* At the time of MMSS,HHMM Time is expressed by a high double-digit of decimal four-digit and a low double-digit of decimal four-digit. (high double-digit 00~99, low double-digit 00~59) * At the time of HHHH, Time is expressed by a high triple-digit of decimal four-digit and a low single-digit of decimal four-digit. (high triple-digit is hour,low single-digit is minute. 1 = 6 minutes)	
0952	Step Control Output 1 PID	No.1~3	R/W
0953	Step Control Output 2 PID	No.1~3	R/W

In the data after Address 0950H, it is necessary to appoint step No. at the time of read/write.
Read/write the data whose address is 0950H or later,,after writing step No. at address 0901H.

9. Supplementary Explanation

9-1. Measuring Range Code Table

Input	Code	Input type	Measuring range				
			°C	°F			
M u l t i I n p u t	Thermo couple	0 1	R 1	0 ~ 1700	0 ~ 3100		
		0 2	K 1	-199.9 ~ 400.0	-300 ~ 700		
		0 3	K 2	0 ~ 1200	0 ~ 2200		
		0 4	K 3	0.0 ~ 300.0	0 ~ 600		
		0 5	J 1	0 ~ 600	0 ~ 1100		
		0 6	T 1	-199.9 ~ 200.0	-300 ~ 400		
		0 7	E 1	0 ~ 700	0 ~ 1300		
		0 8	S 1	0 ~ 1700	0 ~ 3100		
		0 9	U 1	-199.9 ~ 200.0	-300 ~ 400		
		1 0	N 1	0 ~ 1300	0 ~ 2300		
		1 1	B 1 *1	0 ~ 1800	0 ~ 3300		
		1 2	5 - 2 6	0 ~ 2300	0 ~ 4200		
		1 3	P L 2	0 ~ 1300	0 ~ 2300		
	R e s i s t a n c e	bulb	1 4	P 1	-200 ~ 600	-300 ~ 1100	
			1 5	P 2	-100.0 ~ 200.0	-150.0 ~ 400.0	
			1 6	P 3	0.0 ~ 100.0	0.0 ~ 200.0	
			1 7	P 4	-50.0 ~ 50.0	-60.0 ~ 120.0	
			1 8	P 5	-100.0 ~ 300.0	-150.0 ~ 600.0	
			1 9	J P 1	-200 ~ 500	-300 ~ 900	
			2 0	J P 2	-100.0 ~ 200.0	-150.0 ~ 400.0	
			2 1	J P 3	0.0 ~ 100.0	0.0 ~ 200.0	
			2 2	J P 4	-50.0 ~ 50.0	-60.0 ~ 120.0	
			2 3	J P 5	-100.0 ~ 300.0	-150.0 ~ 600.0	
m V	mV	2 4	0 ~ 10mV	By scaling function, measuring range can be set up in the following range arbitrarily. Scaling range : - 1999 ~ 9999 count Span : 10 ~ 10000 count lower limit side < upper-limit side			
		2 5	0 ~ 100mV				
		2 6	-10 ~ 10mV				
		2 7	0 ~ 20mV				
		2 8	0 ~ 50mV				
V o l t a g e	V	2 9	1 ~ 5V			By scaling function, measuring range can be set up in the following range arbitrarily. Scaling range : - 1999 ~ 9999 count Span : 10 ~ 10000 count lower limit side < upper-limit side	
		3 0	0 ~ 5V				
		3 1	-1 ~ 1V				
		3 2	0 ~ 1V				
		3 3	1 ~ 2V				
		3 4	0 ~ 10V				
C u r r e n t	mA	3 5	4 ~ 20mA	By scaling function, measuring range can be set up in the following range arbitrarily. Scaling range : - 1999 ~ 9999 count Span : 10 ~ 10000 count lower limit side < upper-limit side			
		3 6	0 ~ 20mA				

*1 Thermo couple B:400 °C and below 752 °F is not covered by accuracy warranty.

9-2. Event Code Table

	alarm type	code	initial value	setting range
<i>non</i>	none	0	-----	-----
<i>HR</i>	upper limit absolute value	1	measuring range upper limit	within measuring range
<i>LR</i>	lower limit absolute value	2	measuring range lower limit	within measuring range
<i>So</i>	scaling over	3	continuously output at scaling over	
<i>Hd</i>	upper-limit deviation	4	2000 unit	-1999 ~ 2000 unit
<i>Ld</i>	lower limit deviation	5	-1999 unit	-1999 ~ 2000 unit
<i>ld</i>	within deviation	6	0 unit	0 ~ 2000 unit
<i>od</i>	outside deviation	7	2000 unit	0 ~ 2000 unit
<i>run</i>	RUN signal	8	continuously output at RUN execution	
<i>ct1</i>	control loop 1	9	0.0 A	0.0 ~ 50.0 A
<i>ct2</i>	control loop 2	10	0.0 A	0.0 ~ 50.0 A
<i>stp</i>	step signal	11	PROG—outputs for 1 second at step end	
<i>P.E</i>	pattern end signal	12	PROG—outputs for 3 seconds at pattern end	
<i>End</i>	program end signal	13	PROG—outputs for 3 seconds at program end	
<i>Hold</i>	hold signal	14	PROG— continuously output at hold execution	
<i>Prog</i>	program signal	15	continuously output at PROG	
<i>u.SI</i>	up slope signal	16	PROG—outputted while the program is ascending	
<i>d.SI</i>	down slope signal	17	PROG—outputted while the program is descending	
<i>GuR</i>	guarantee signal	18	0 unit	0 ~ 2000 unit

10. ASC II □ Code Table

	b 7 ~ b 5	0 0 0	0 0 1	0 1 0	0 1 1	1 0 0	1 0 1	1 1 0	1 1 1
b 4 ~ b 1		0	1	2	3	4	5	6	7
0 0 0 0	0	NUL	TC7 (DLE)	SP	0	@	P	`	p
0 0 0 1	1	TC1 (SOH)	DC1	!	1	A	Q	a	q
0 0 1 0	2	TC2 (STX)	DC2	"	2	B	R	b	r
0 0 1 1	3	TC3 (ETX)	DC3	#	3	C	S	c	s
0 1 0 0	4	TC4 (EOT)	DC4	\$	4	D	T	d	t
0 1 0 1	5	TC5 (ENQ)	TC8 (NAK)	%	5	E	U	e	u
0 1 1 0	6	TC6 (ACK)	TC9 (SYN)	&	6	F	V	f	v
0 1 1 1	7	BEL	TC10 (ETB)	'	7	G	W	g	w
1 0 0 0	8	FE0 (BS)	CAN	(8	H	X	h	x
1 0 0 1	9	FE1 (HT)	EM)	9	I	Y	i	y
1 0 1 0	A	FE2 (LF)	SUB	*	:	J	Z	j	z
1 0 1 1	B	FE3 (VT)	ESC	+	;	K	[k	{
1 1 0 0	C	FE4 (FF)	IS4 (FS)	,	<	L	\	l	
1 1 0 1	D	FE5 (CR)	IS3 (GS)	-	=	M]	m	}
1 1 1 0	E	SO	IS2 (RS)	.	>	N	^	n	~
1 1 1 1	F	SI	IS1 (US)	/	?	O	_	o	DEL

The contents of this instruction are subject to change without notice.

SHIMAX CO., LTD.

URL: <http://www.shimax.co.jp>

Head Office 11-5 Fujimi-cho, Daisen City, Akita 014-0011 Japan
Phone: +81-187-86-3400 Facsimile: +81-187-62-6402

PRINTED IN JAPAN